

SENCOR®

SWS 9300



USER MANUAL

UŽIVATELSKÁ PŘÍRUČKA

POUŽÍVATEĽSKÁ PRÍRUČKA

FELHASZNÁLÓI KÉZIKÖNVI

INSTRUKCJA OBSŁUGI

**COLOR WEATHER STATION
WITH 5-IN-1 SENSOR**

**METEOROLOGICKÁ STANICE S BAREVNÝM
DISPLEJEM A SNÍMAČEM 5-V-1**

**METEOROLOGICKÁ STANICA S FAREBNÝM
DISPLEJOM A SNÍMAČOM 5-V-1**

**METEOROLÓGIAI ÁLLOMÁS SZÍNES KIJELZŐVEL
ÉS 5 AZ 1-BEN ÉRZÉKELŐVEL**

**STACJA POGODOWA Z KOLOROWYM
WYŚWIETLACZEM I CZUJNIKIEM 5-W-1**

EN CZ SK HU PL

INTRODUCTION

Thank you for your purchase of this delicate color weather station with 5-IN-1 sensor.

The wireless 5-IN-1 sensor contains a self-emptying rain collector for measuring rainfall, anemometer, and wind vane, temperature and humidity sensors. It is fully assembled and calibrated for your easy installation. It sends data by a low power radio frequency to the console up to 150m away (line of sight).

The colourful display main unit displays all the weather data received from the 5-IN-1 sensor outside. It remembers the data for a time range for you to monitor and analyze the weather status for past 24 hours. It has advance features such as the HI / LO Alert alarm which will alert the user when the set high or low weather criteria are met. The barometric pressure records are computed to give users forthcoming weather forecast and stormy warning. Day and date stamps are also provided to the corresponding maximum and minimum records for each weather details.

The system also analyzes the records for your convenient viewing, such as the display of rainfall in terms of rain rate, daily, weekly and monthly records, whereas wind-speed in different levels. Different useful readings such as Feels like, Wind-chill, Heat Index, Dew-point, Comfort level are also provided.

With Radio-controlled / Atomic clock feature built-in, the system is truly a remarkable personal Professional Weather Station for your own backyard.

NOTE:

This instruction manual contains useful information on the proper use and care of this product. Please read this manual through to fully understand and enjoy its features, and keep it handy for future use.

OVERVIEW

CONSOLE

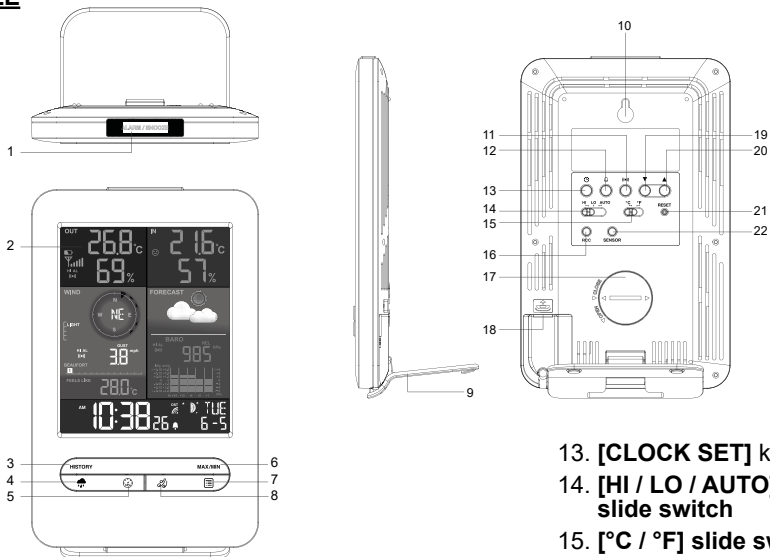

1. **[ALARM/SNOOZE]** key
2. LCD display
3. **[HISTORY]** key
4. **[RAIN]** key
5. **[BARO]** key
6. **[MAX / MIN]** key
7. **[INDEX]** key
8. **[WIND]** key
9. Table stand
10. Wall mount hole
11. **[ALERT]** key
12. **[ALARM]** key

13. **[CLOCK SET]** key
14. **[HI / LO / AUTO]** slide switch
15. **[°C / °F]** slide switch
16. **[RCC]** key
17. Battery compartment
18. USB Power socket
19. **[DOWN]** key
20. **[UP]** key
21. **[RESET]** key
22. **[SENSOR]** key

WIRELESS 5-IN-1 SENSOR

1. Rain collector
2. Balance indicator
3. Antenna
4. Wind cups
5. Mounting pole
6. Radiation shield
7. Wind vane
8. Mounting base
9. Mounting clamp
10. Red LED indicator
11. [RESET] key
12. Battery door
13. Mounting clamp screws

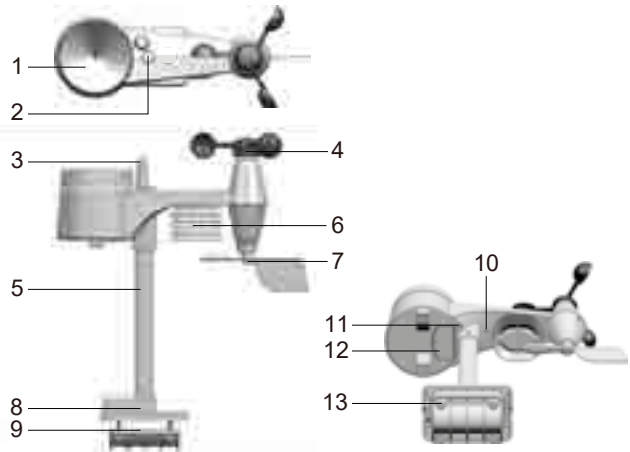

AIN GAUGE

1. Rain collector
2. Tipping bucket
3. Rain sensor
4. Drain holes



TEMPERATURE AND HUMIDITY SENSOR

1. Radiation shield Sensor casing
2. Temperature and humidity sensor

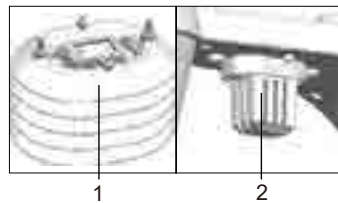

WIND SENSOR

1. Wind cups (anemometer)
2. Wind vane

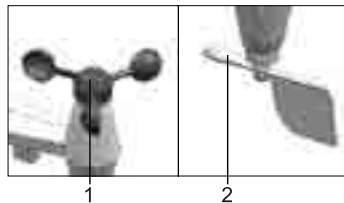

LCD DISPLAY

NORMAL TIME AND CALENDAR SECTION

1. Time
2. DST
3. RCC signal strength indicator
4. Moon phase
5. Day of the week
6. Date



INDOOR TEMPERATURE AND HUMIDITY

1. Indoor indicator
2. Comfort indication
3. Indoor temperature
4. Indoor humidity

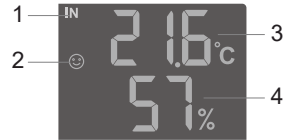

OUTDOOR TEMPERATURE AND HUMIDITY

1. Outdoor indicator
2. Outdoor sensor low battery indicator
3. Outdoor signal strength indicator
4. Outdoor temperature
5. Outdoor humidity

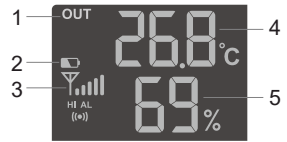

WEATHER FORECAST

Weather forecast icon



BAROMETER

1. BARO indicator
2. Barometer reading
3. History graph
4. Hourly records indicator
5. ABSOLUTE / RELATIVE indicator
6. Barometer measurement unit (hPa / inHg / mmHg)



RAINFALL

1. RAINFALL indicator
2. Hi Alert and Alarm
3. Time range record indicator
4. Day records indicator
5. History graph
6. Current Daily rainfall
7. Rainfall unit (inch / mm)

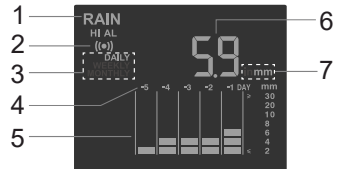

WIND SPEED / DIRECTION

1. WIND indicator
2. Current wind direction reading
3. Wind speed levels
4. Hi Alert and Alarm
5. Beaufort levels
6. Current wind direction indicator
7. Wind direction indicator during the last hour
8. AVERAGE / GUST wind indicator
9. Wind speed unit (mph / m/s / km/h / knot)
10. Wind speed reading

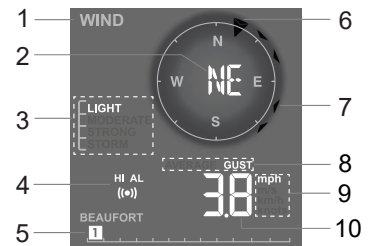

WEATHER INDEX

1. FEELS LIKE / WIND CHILL / HEAT INDEX / DEW POINT indicator
2. FEELS LIKE / WIND CHILL / HEAT INDEX / DEW POINT reading



INSTALLATION

WIRELESS 5-IN-1 SENSOR

Your wireless 5-IN-1 sensor measures wind speed, wind direction, rainfall, temperature and humidity for you.

It's fully assembled and calibrated for your easy installation.

BATTERY AND INSTALLATION

Unscrew the battery door at bottom of unit and insert the batteries according to the +/- polarity indicated. Screw the battery door compartment on tightly.

NOTE:

3. Ensure the water tight O-ring is properly aligned in place to ensure water resistant.
4. The red LED will begin flashing every 12 seconds.

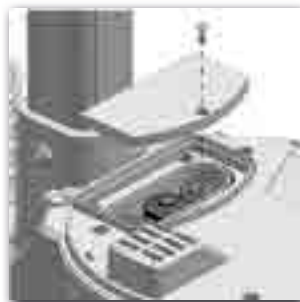

ASSEMBLY THE STAND AND POLE

<p>Step 1 Insert the top side of the pole to the square hole of the weather sensor.</p> <p>NOTE: Ensure the pole and sensor's indicator align.</p>	
<p>Step 2 Place the nut in the hexagon hole on the sensor, then insert the screw in other side and tighten it by the screw driver.</p>	
<p>Step 3 Insert the other side of the pole to the square hole of the plastic stand.</p> <p>NOTE: Ensure the pole and stand's indicator align.</p>	

Step 4

Place the nut in the hexagon hole of the stand, then insert the screw in other side and then tighten it by the screw driver.

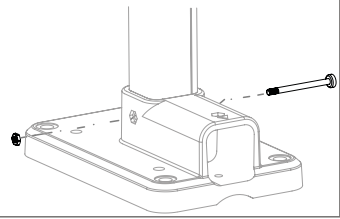

Install the wireless 5-IN-1 sensor in an open location with no obstructions above and around the sensor for accurate rain and wind measurement. Install the sensor with the smaller end facing the North to properly orient the wind direction vane. Secure the mounting stand and clamps (included) to a post or pole, and allow minimum 1.5m off the ground.

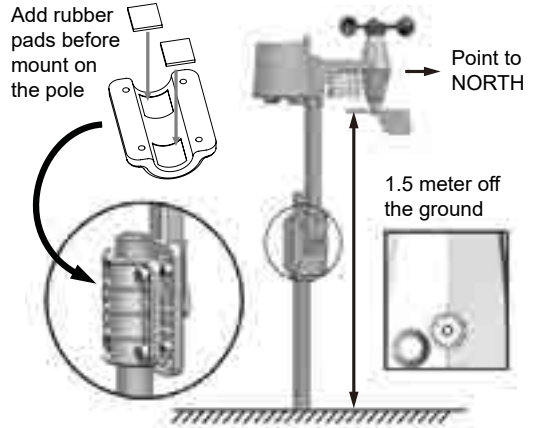

MOUNTING GUIDELINES

1. Install the wireless 5-IN-1 sensor at least 1.5m off the ground for better and more accurate wind measurements.
2. Choose an open area within 150 meters from the LCD console.
3. Install the wireless 5-IN-1 sensor as level as possible to achieve accurate rain and wind measurements.
4. Mount the wireless 5-IN-1 sensor with the wind meter end pointing to the North to correctly orient direction of the wind vane.

A. Mounting on pole
(Pole Diameter
1"~1.3") (25~33mm)



B. Mounting on
the railing

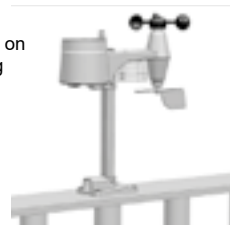

CONSOLE

BACKUP BATTERY INSTALLATION

1. Remove the battery door on the back side of the console.
2. Insert CR2032 button cell as per the polarity information marked on the battery compartment.
3. Replace the battery door.

POWER UP THE CONSOLE

1. Plug the power adapter USB plug to power up the main unit.
2. Once the main unit power up, all the segments of the LCD will be shown briefly before entering the radiocontrolled time reception mode.
3. The RC clock will automatically start scanning for the radio-controlled time signal in 8 seconds and the LCD backlight will temporary switch to low brightness level.

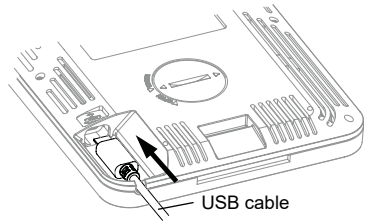

NOTE:

- If no display appears on the LCD after inserting the batteries, press **[RESET]** key by using a pointed object.
- In some cases, you may not receive the signal immediately due to the atmospheric disturbance.

TABLE STAND INSTALLATION

The unit is designed for desktop or wall mount for easy viewing. Follow the steps to hook the table stand on the bottom of the console.

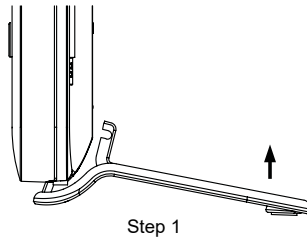

Step 1

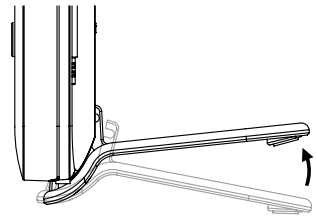

Step 2

PAIRING OF WIRELESS 5-IN-1 SENSOR WITH CONSOLE

After power up, the console will automatically search and connect the wireless 5-IN-1 sensor (antenna blinking).

Once the connection is successful, antenna mark and readings of outdoor temperature, humidity, wind speed, wind direction, and rainfall will appear on the display.

CHANGING BATTERIES AND MANUAL PAIRING OF SENSOR

Whenever you changed the batteries of the wireless 5-IN-1 sensor, pairing must be done manually.

1. Change all the batteries to new ones.
2. Press **[SENSOR]** key on the console.
3. Press **[RESET]** key on the sensor.

NOTE:

- Pressing **[RESET]** key at bottom of wireless 5-IN-1 sensor will generate a new code for pairing purpose.
- Always dispose old batteries in an environmentally safe manner.

RADIO CONTROLLED / ATOMIC CLOCK FUNCTION

When the unit receives RCC signal, a sync-time symbol  will appear on the LCD, and synchronizes daily.

SIGNAL STRENGTH INDICATOR

The signal indicator displays signal strength in 4 levels. Wave segment flashing means time signals are being received. The signal quality could be classified into four types:



NOTE:

- Everyday the unit will automatically search for the time signal at 2:00am, 8:00am, 2:00pm and 8:00pm
- The strength of radio-controlled time signal from the transmitter tower may be affected by geographical location or building around.
- Always place the unit away from interfering sources such as TV set, computer, etc.
- Avoid placing the unit on or next to metal plates.
- Closed areas such as airport, basement, tower block, or factory are not recommended.

TIME SETTING

The unit automatically set itself accordingly to the Radio Controlled Clock signal it received. To set the clock/ calendar manually, first disable the reception by holding the RCC key for 8 seconds.

TO MANUALLY SET THE CLOCK / TIME ZONE SELECTION

1. Press and hold **[TIME]** key for 2 seconds until 12 or 24 Hr flashes.
2. Use **[UP]** or **[DOWN]** key to adjust, and press **[TIME]** key to proceed to the next setting.
3. Press **[TIME]** key again to step the setting items in this sequence: Hour format → Hour → Minute → Second → Year → Month → Day → Hour offset → Weekday Language → DST AUTO / OFF.

NOTE:

- The unit will automatically exit setting mode if no key was pressed in 60 seconds.
- The hour offset is for DCF and MSF version. Its range is between -23 and +23 hours.
- **DST** (Daylight Saving Time) feature is set to Auto (factory set). The clock has been programmed to automatically switch when the daylight saving time is in effect. User can set the **DST** to **OFF** to disable the feature.

DISABLE / ENABLE RCC SIGNAL RECEPTION

1. Press and hold the **[RCC]** key 8 seconds to disable the reception.
2. Press and hold the **[RCC]** key 8 seconds to enable automatic RCC reception.

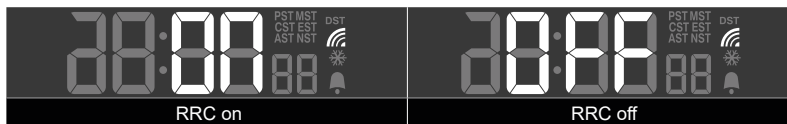

SETTING ALARM TIME

1. In normal time mode, press and hold **[ALARM]** key for 2 seconds until the alarm hour digit flashes to enter alarm time setting mode.
2. Press **[UP]** or **[DOWN]** key to change the value. Press and hold the key for quick-adjust.
3. Press **[ALARM]** key again to step the setting value to Minute with the Minute digit flashing.
4. Press **[UP]** or **[DOWN]** key to adjust the value of the flashing digit.

5. Press **[ALARM]** key to save and exit the setting.

NOTE:

- In alarm mode, the “” icon will display on the LCD.
- The alarm function will turn on automatically once you set the alarm time.

ACTIVATING ALARM AND TEMPERATURE PRE-ALARM FUNCTION

1. In normal mode, press **[ALARM]** key to show the alarm time for 5 seconds.
2. When the alarm time displays, press **[ALARM]** key again to activate the alarm function.
Or press **[ALARM]** key twice to activate the alarm with ice pre-alarm function.

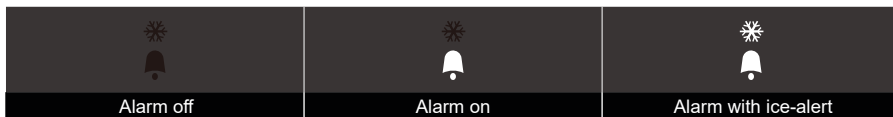

TO SET THE ALARM TIME

1. Press and hold the **[ALARM]** key for 2 seconds to enter alarm setting mode **HOUR** will begin to flash.
2. Use **[UP]** or **[DOWN]** key to adjust **HOUR**, and press the **[ALARM]** key to proceed to set **MINUTE**.
3. Repeat 2 above to set **MINUTE**, and then press the **[ALARM]** key to exit.

NOTE:

- Pressing the **[ALARM]** key twice when alarm time is being displayed will activate the temperature-adjusted pre-alarm.
- The alarm will sound 30 minutes earlier if it detects outside temperature is below -3°C.

WEATHER FORECAST

The device contains sensitive pressure sensor built-in with sophisticated and proven software that predicts weather for the next 12 ~ 24 hours within a 30 to 50 km (19-31 miles) radius.



NOTE:

- The accuracy of a general pressure-based weather forecast is about 70% to 75%.
- The weather forecast is meant for the next 12 hours, it may not necessarily reflect the current situation.
- The weather icon will flash on display when the rainstorm comes.
- The **SNOWY** weather forecast is not based on the atmospheric pressure, but based on the outdoor temperature. When the outdoor temperature is below -3°C (26°F), the **SNOWY** weather indicator will be displayed on the LCD.

BAROMETRIC/ATMOSPHERIC PRESSURE

TO SELECT THE PRESSURE DISPLAY MODE

1. Press and hold the **[BARO]** key for 2 seconds to enter select model:
2. Press **[UP]** or **[DOWN]** key to select between:
 - **ABS** the absolute atmospheric pressure of your location.
 - **REL** the relative atmospheric pressure based on the sea.
3. In “**ABS**” mode, press **[BARO]** key to exit, In “**REL**” mode, press **[BARO]** key to set relative atmospheric pressure value in next section.

TO SET RELATIVE ATMOSPHERIC PRESSURE VALUE

1. Get the atmosphere pressure data of the sea level (it is also the relative atmosphere pressure data of your home area) through the local weather service, internet and other weather channels.
2. Press and hold the **[BARO]** key for 2 seconds until ABS or REL icon flashes.
3. Press **[UP]** or **[DOWN]** key to switch to relative pressure mode.
4. Press **[BARO]** key once again until the relative atmospheric pressure digit flashes.
5. Press **[UP]** or **[DOWN]** key to change the value.
6. Press **[BARO]** key to save and exit the setting mode.

TO SELECT THE MEASUREMENT UNIT FOR THE BAROMETER

Use **[BARO]** key to change the unit between inHg / mmHg / hPa.

NOTE:

- When power up the main unit, it will display the relative pressure reading and default value is 1013 mb/hPa (29.91 inHg), which refers to the average atmosphere pressure.
- When you change the relative atmospheric pressure value, the weather indicators will change along with it.
- The relative atmospheric pressure is based on the sea level, but it will change with the absolute atmospheric pressure changes after operating the clock for 1 hour.

RAINFALL

TO SELECT THE RAINFALL DISPLAY MODE

NOTE:

The device displays how many mm/inches of rain are accumulated in an hour time period, based on current rainfall rate. Press the **[RAIN]** key to toggle between:

- **RATE** Current rainfall rate in past an hour
- **DAILY** The DAILY display indicate the total rainfall from midnight
- **WEEKLY** The WEEKLY display indicate the total rainfall from the current week
- **MONTHLY** The MONTHLY display indicate the total rainfall from the current calendar month

			
Rainfall rate	Daily rainfall	Weekly rainfall	Monthly rainfall

NOTE:





Rain rate is updated every 6 minutes, at every hour on the hour, and at 6, 12, 18, 24, 30, 36, 42, 48, 54 minute past the hour.

TO SELECT THE MEASUREMENT UNIT FOR THE RAINFALL

1. Press and hold the **[RAIN]** key 2 seconds to enter unit setting mode.
2. Use **[UP]** or **[DOWN]** key to toggle between **mm** (millimeter) and **in** (inch).
3. Press the **[RAIN]** key to confirm and exit.

WIND SPEED / WIND DIRECTION

TO READ THE WIND DIRECTION

Wind Direction Indicator	Meaning	
	Real-time wind direction	 
	Wind directions appeared in last 5 minutes (max 6 indicator mark)	

TO SELECT THE WIND DISPLAY MODE

Press the **[WIND]** key to toggle between:

- **AVERAGE:** The AVERAGE wind speed will display the average of all wind speed numbers recorded in the previous 30 seconds.
- **GUST:** The GUST wind speed will display the highest wind speed recorded from last reading.

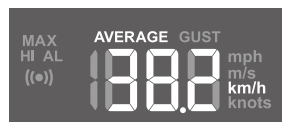

The wind level provides a quick reference on the wind condition and is indicated by a series of text icons.

Level	LIGHT	MODERATE	STRONG	STORM
Speed	1 ~ 19 KM/H	20 ~ 49 KM/H	50 ~ 88 KM/H	> 88 KM/H

TO SELECT WIND SPEED UNIT

1. Press and hold **[WIND]** key for 2 seconds to enter unit setting mode.
2. Use **[UP]** or **[DOWN]** key to change the unit between **mph** (miles per hour) / **m/s** (meter per second) / **km/h** (kilometer per hour) / **knots**.
3. Press **[WIND]** key to confirm and exit.

BEAUFORT SCALE

Beaufort scale is an international scale of wind velocities from 0 (calm) to 12 (Hurricane force).

Beaufort Scale	Description	Wind Speed	Land Condition
0	Calm	< 1 km/h	Calm. Smoke rises vertically.
		< 1 mph	
		< 1 knot	
		< 0.3 m/s	
1	Light air	1.1 ~ 5.5 km/h	Smoke drift indicates wind direction. Leaves and wind vanes are stationary.
		1 ~ 3 mph	
		1 ~ 3 knot	
		0.3 ~ 1.5 m/s	

2	Light breeze	5.6 ~ 11 km/h	Wind felt on exposed skin. Leaves rustle. Wind vanes begin to move.
		4 ~ 7 mph	
		4 ~ 6 knot	
		1.6 ~ 3.3 m/s	
3	Gentle breeze	12 ~ 19 km/h	Leaves and small twigs constantly moving, light flags extended.
		8 ~ 12 mph	
		7 ~ 10 knot	
		3.4 ~ 5.4 m/s	
4	Moderate breeze	20 ~ 28 km/h	Dust and loose paper raised. Small branches begin to move.
		13 ~ 17 mph	
		11 ~ 16 knot	
		5.5 ~ 7.9 m/s	
5	Fresh breeze	29 ~ 38 km/h	Branches of a moderate size move. Small trees in leaf begin to sway.
		18 ~ 24 mph	
		17 ~ 21 knot	
		8.0 ~ 10.7 m/s	
6	Strong breeze	39 ~ 49 km/h	Large branches in motion. Whistling heard in overhead wires. Umbrella use becomes difficult. Empty plastic bins tip over.
		25 ~ 30 mph	
		22 ~ 27 knot	
		10.8 ~ 13.8 m/s	
7	High wind	50 ~ 61 km/h	Whole trees in motion. Effort needed to walk against the wind.
		31 ~ 38 mph	
		28 ~ 33 knot	
		13.9 ~ 17.1 m/s	
8	Gale	62 ~ 74 km/h	Some twigs broken from trees. Cars veer on road. Progress on foot is seriously impeded.
		39 ~ 46 mph	
		34 ~ 40 knot	
		17.2 ~ 20.7 m/s	
9	Strong gale	75 ~ 88 km/h	Some branches break off trees, and some small trees blow over. Construction /temporary signs and barricades blow over.
		47 ~ 54 mph	
		41 ~ 47 knot	
		20.8 ~ 24.4 m/s	
10	Storm	89 ~ 102 km/h	Trees are broken off or uprooted, structural damage likely.
		55 ~ 63 mph	
		48 ~ 55 knot	
		24.5 ~ 28.4 m/s	

11	Violent storm	103 ~ 117 km/h	Widespread vegetation and structural damage likely.
		64 ~ 73 mph	
		56 ~ 63 knot	
		28.5 ~ 32.6 m/s	
12	Hurricane force	≥ 118 km/h	Severe widespread damage to vegetation and structures. Debris and unsecured objects are hurled about.
		≥ 74 mph	
		≥ 64 knot	
		≥ 32.7m/s	

WEATHER INDEX

At the WEATHER INDEX section, you can press **[INDEX]** key to view the weather index in this sequence:

FEELS LIKE → WIND CHILL → HEAT INDEX → DEW POINT.

FEELS LIKE

The feels like temperature index determine how the outdoor temperature that people actually feel.

HEAT INDEX

The heat index, which is determined by the wireless 5-IN-1 sensor's temperature & humidity data, when the outdoor temperature is between 27°C (80°F) and 50°C (120°F).

Heat Index range	Warning	Explanation
27°C to 32°C (80°F to 90°F)	Caution	Possibility of heat exhaustion
33°C to 40°C (91°F to 105°F)	Extreme Caution	Possibility of heat dehydration
41°C to 54°C (106°F to 129°F)	Danger	Heat exhaustion likely
≥55°C (≥130°F)	Extreme Danger	Strong risk of dehydration / sun stroke

WIND CHILL

A combination of the wireless 5-IN-1 sensor's temperature and wind speed data determines the current wind chill factor.

DEW POINT

- The dew point is the temperature below which the water vapor in air at constant barometric pressure condenses into liquid water at the same rate at which it evaporates. The condensed water is called dew when it forms on a solid surface.
- The dew point temperature is determined by the temperature & humidity data from wireless 5-IN-1 sensor.

HISTORY DATA (ALL RECORDS IN THE PAST 24 HOURS)

The console will record past 24 hours weather data automatically that included past indoor and outdoor temperature & humidity, baro, wind chill, wind speed and rainfall records.

1. Press the **[HISTORY]** key to check past 1 hour history records.
2. Press **[HISTORY]** key repeatedly to show past 2, 3, 4, 5.....24 history weather records.

MAX/MIN MEMORY FUNCTION

1. Press the **MAX/MIN** key to check the maximum/minimum records. The checking orders will be: Outdoor max temperature → Outdoor min temperature → Outdoor max humidity → Outdoor min humidity → Indoor max temperature → Indoor min temperature → Indoor Max humidity → Indoor min humidity → Max feels like temperature → Min feels like temperature → Max wind chill → Min wind chill → Max heat index → Min heat index → Max dew point → Min dew point → Max pressure → Min pressure → Max average wind speed → Max gust → Max rainfall.
2. Press and hold the **[MAX / MIN]** key for 2 seconds to reset the maximum and minimum records.

NOTE:

When maximum or minimum reading is displayed, the corresponding time stamp will be shown.

HI / LO ALERT

HI / LO alert are used to alert you of certain weather conditions. Once activated, the alarm will turn on. The following are areas and type of alert provided:

Display segment	Type of alert available
Indoor temperature	HI and LO alert
Indoor humidity	HI and LO alert
Outdoor temperature	HI and LO alert
Outdoor humidity	HI and LO alert
Rainfall	HI alert (Daily rainfall since midnight)
Wind speed	HI alert

TO SET THE HI / LO ALERT

1. Press the **[ALERT]** key until the desired area is selected.
2. Use **[UP]** or **[DOWN]** key to adjust the setting.
3. Press the **[ALERT]** key to confirm and continue to next setting.



TO ENABLE / DISABLE THE HI / LO ALERT

1. Press the **[ALERT]** key until the desired area is selected.
2. Press the **[ALARM]** key to turn the alert on or off.
3. Press the **[ALERT]** key to continue to next setting.



NOTE:

- The unit will automatically exit setting mode in 5 seconds if no key is pressed.
- When ALERT alarm is on, the area and type of alarm that triggered the alarm will be flashing and the alarm will sound for 2 minutes.
- To silence the Alert alarm beeping, press the **[ALARM / SNOOZE]** / **[ALARM]** key, or let the beeping alarm automatically turn off after 2 minutes.

WIRELESS SIGNAL RECEPTION

The 5-IN-1 sensor is capable of transmitting data wirelessly over an approximate operating of 150m range (line of sight). Occasionally, due to intermittent physical obstructions or other environmental interference, the signal may be weakened or lost. In case that the sensor signal is lost completely, you will need to relocate the Console or the wireless 5-IN-1 sensor.



TEMPERATURE & HUMIDITY

COMFORT INDICATION

The comfort indication is a pictorial indication based on indoor air temperature and humidity in an attempt to determine comfort level.



NOTE:

- Comfort indication can vary under the same temperature, depending on the humidity.
- here is no comfort Indication when temperature is below 0°C (32°F) or over 60°C (140°F).

DATA CLEARING

During installation of the wireless 5-IN-1 sensor, the sensors were likely to be triggered, resulting in erroneous rainfall and wind measurements. After the installation, user may clear out all the erroneous data from the Console, without needing to reset the clock and re-establish pairing. Simply press and hold the **[HISTORY]** key for 8 seconds. This will clear out any data recorded before.

BACKLIGHT

The main unit backlight can be adjust, using the **[HI / LO / AUTO]** sliding switch to select the appropriate brightness:

- Slide to the **[HI]** position for the brighter backlight.
- Slide to the **[LO]** position for the dimmer backlight.
- Slide to the **[AUTO]** position for the auto adjust backlight that according to environment light level.

POINTING 5-IN-1 SENSOR TO THE SOUTH

The outdoor 5-IN-1 sensor is calibrated to be pointing to North by default. However, in some cases, users may wish to install the product with the arrow pointing towards the South:

1. First install the outdoor 5-IN-1 sensor with its arrow pointing to the South.
2. On the Console, press and hold the **[WIND]** key for 8 seconds until the upper part (Northern Hemisphere) of the compass lights up and blinking.

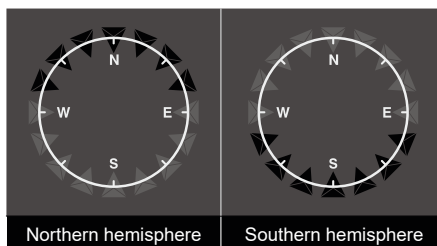

- Use **[UP]** or **[DOWN]** key to change to lower part (Southern Hemisphere).
- Press the **[WIND]** key to confirm and exit.

NOTE:

Changing from hemisphere setting will automatically switch the direction of the moon phase on the display.

MOON PHASE

In the Northern hemisphere, the moon waxes (the part of the moon we see that glows after the New Moon) from the right. Hence the sun-lit area of the moon moves from right to left in the Northern Hemisphere, while in the Southern Hemisphere, it moves from left to right. Below is the table which illustrate how the moon will appear on the console.

Northern hemisphere	Moon Phase	Southern hemisphere
	New Moon	
	Waxing Crescent	
	First quarter	
	Waxing Gibbous	
	Full Moon	
	Waning Gibbous	
	Third quarter	
	Waning Crescent	

MAINTENANCE

TO CLEAN THE RAIN COLLECTOR

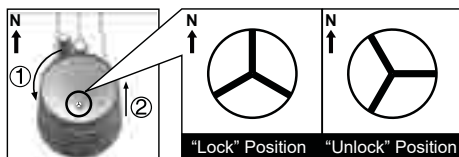

- Rotate the rain collector by 30° anti-clockwise.
- Gently remove the rain collector.
- Clean and remove any debris or insects.
- Install all the parts when they are fully clean and dried.



TO CLEAN THE THERMO/HYGRO SENSOR

- Unscrew the 2 screws at the bottom of the radiation shield.
- Gently pull out the shield.
- Remove carefully any dirt or insects inside the sensor casing (Do not let the sensors inside get wet).
- Clean the shield with water and remove any dirt or insects.
- Install all the parts back when they are fully clean and dried.

TROUBLESHOOTING

Problem / Symptom	Solution
Strange or no measurement of Rain Sensor	<ol style="list-style-type: none"> 1. Check the drain hole in the rain collector. 2. Check the balance indicator.
Strange or no measurement of Thermo / Hygro Sensor	<ol style="list-style-type: none"> 1. Check the radiation shield. 2. Check the sensor casing.
Strange or no measurement of Wind Speed and Direction	<ol style="list-style-type: none"> 1. Check wind cups (Anemometer). 2. Check the wind vane.
⚡ and  (Signal lost for 15 minutes) ⚡ and  (Signal lost for 1 hour)	<ol style="list-style-type: none"> 1. Relocate the console and 5-in-1 sensor closer to each other. 2. Make sure the console is placed away from other electronic appliances that may interfere with the wireless communication (TVs, computers, microwaves). 3. If problem continues, reset both console and 5-in-1 sensor.

PRECAUTIONS

- Read and keep these instructions.
- Heed all warnings and follow all instructions.
- Do not subject the unit to excessive force, shock, dust, temperature or humidity.
- Do not cover the ventilation holes with any items such as newspapers, curtains etc.
- Do not immerse the unit in water. If you spill liquid over it, dry it immediately with a soft, lint-free cloth.
- Do not clean the unit with abrasive or corrosive materials.
- Do not tamper with the unit's internal components. This invalidates the warranty.
- Only use attachments/accessories specified by the manufacturer.
- Images shown in this manual may differ from the actual display.
- Placement of this product on certain types of wood may result in damage to its finishing for which manufacture will not be responsible. Consult the furniture manufacturer's care instructions for information.
- The socket-outlet shall be installed near the equipment and shall be easily accessible.
- Only use fresh batteries. Do not mix new and old batteries.
- Risk of explosion if battery is replaced by an incorrect type.
- Do not dispose old batteries as unsorted municipal waste, dispose of used batteries according to the instructions. Collection of such waste separately for special treatment is necessary.
- Place the unit at least 1m from the adaptor.
- An appliance is only suitable for mounting at height ≤ 2m. (Equipment mass ≤ 1kg)
- The technical specifications for this product and the contents of the user manual are subject to change without notice.
- When disposing of this product, ensure it is collected separately for special treatment.



SPECIFICATIONS

CONSOLE	
Dimensions (W × H × D)	118 × 192.5 × 21mm (without attach table stand)
Weight	260g
Main power	5V DC 600mA input adaptor
Backup battery	CR2032
Support sensor	Wireless 5-in-1 sensor (Wind speed, Wind direction, Rain gauge, thermo-hygro)
RF frequency	868Mhz (for EU or UK version)
RADIO-CONTROLLED / ATOMIC CLOCK	
Synchronization	Auto or disabled
Clock display	HH:MM:SS / Weekday
Hour format	12hr AM / PM or 24hr
Calendar	DD / MM
Weekday in 5 languages	EN, FR, DE, ES, IT
Time signal	DCF or MSF (base on the country version)
DST	AUTO / OFF
INDOOR BAROMETER	
Barometer unit	hPa, inHg and mmHg
Measuring range	540 ~ 1100hPa
Accuracy	(700 ~ 1100hPa ± 5hPa) / (540 ~ 696hPa ± 8hPa) (20.67 ~ 32.48inHg ± 0.15inHg) / (15.95 ~ 20.55inHg ± 0.24inHg) (525 ~ 825mmHg ± 3.8mmHg) / (405 ~ 522mmHg ± 6mmHg) Typical at 25°C (77°F)
Resolution	1 hPa / inHg is 2 decimal place / mmHg is 1 decimal place
Weather forecast	Sunny/Clear, Slightly Cloudy, Cloudy, Rainy, Rainy/Stormy and Snowy
Memory modes	Max & Min from last memory reset (with time stamp), Historical data of past 24 hours
INDOOR TEMPERATURE	
Temperature unit	°C or °F
Displayed range	-40°C to 70°C (-40°F to 158°F)
Operating range	-5°C to 50°C (14°F to 122°F)
Resolution	°C / °F (1 decimal place)
Accuracy	<0°C or >40°C ± 2°C (<32°F or >104°F ± 3.6°F) 0~40°C ± 1°C (32~104°F ± 1.8°F)
Memory modes	Max & Min from last memory reset (with time stamp), Historical data for last 24hrs

INDOOR HUMIDITY	
Displayed range	20% to 90% RH (<20%: LO; > 90%: HI) (Temperature between 0°C to 60°C)
Operating range	20% to 90% RH
Resolution	1%
Accuracy	20 ~ 40% RH, ± 8% RH, at 25°C (77°F) 41% ~ 70% RH, ± 5% RH, at 25°C (77°F) 71% ~ 90% RH, ± 8% RH, at 25°C (77°F)
Memory modes	Max & Min from last memory reset (with time stamp), Historical data for last 24hrs
OUTDOOR TEMPERATURE (Note: Data detect from wireless 5-in-1 sensor)	
Temperature unit	°C or °F
Displayed range	-40°C to 80°C (-40°F to 176°F)
Resolution	°C / °F (1 decimal place)
Accuracy	60.1 ~ 80°C ± 0.8°C (140.2 ~ 176°F ± 1.4°F) 5.1 ~ 60°C ± 0.4°C (41.2 ~ 140°F ± 0.7°F) -19.9 ~ 5°C ± 1°C (-3.8 ~ 41°F ± 1.8°F) -40 ~ -20°C ± 1.5°C (-40 ~ -4°F ± 2.7°F)
Memory mode	Max & Min from last memory reset (with time stamp), Historical data for last 24hrs
OUTDOOR HUMIDITY (Note: Data detect from wireless 5-in-1 sensor)	
Displayed range	0% to 100% RH
Resolution	1%
Accuracy	1 ~ 20% RH ± 6.5% RH @ 25°C (77°F) 21 ~ 80% RH ± 3.5% RH @ 25°C (77°F) 81 ~ 99% RH ± 6.5% RH @ 25°C (77°F)
Memory modes	Max & Min from last memory reset (with time stamp), Historical data for last 24hrs
RAIN (Note: Data detect from wireless 5-in-1 sensor)	
Unit for rainfall	mm and in
Range for rainfall	0~9999mm (0~393.7inches)
Resolution	0.4 mm (0.0157 in)
Accuracy for rainfall	Greater of +/- 7% or 1 tip
Memory modes	Max rainfall from last memory reset, Historical data for last 24hrs
WIND (Note: Data detect from wireless 5-in-1 sensor)	
Wind speed unit	mph, m/s, km/h, knots
Wind speed range	0~112mph, 50m/s, 180km/h, 97knots
Wind speed resolution	0.1mph or 0.1knot or 0.1m/s
Speed accuracy	< 5m/s: +/- 0.5m/s; > 5m/s: +/- 6%

Direction resolutions	16
Memory modes	Max average wind speed & gust (with time stamp), Historical data for last 24hrs

WIRELESS 5-IN-1 SENSOR

Dimensions (W × H × D)	343.5 × 393.5 × 136 mm
Weight	673g with batteries
Operating temperature range	-40°C to 60°C (-40°F to 140°F)
Operating humidity range	1% to 99% RH
Battery	3 × AA size 1.5V battery (Lithium battery recommended for low temperature usage)
RF Frequency	868 MHz (for EU or UK version)
RF transmission range	Up to 150 meters
Transmission	Every 12 seconds

ADAPTER TECHNICAL SPECIFICATIONS:

Manufacturer's name or trade mark, commercial registration number and address:	HUA XU ELECTRONICS FACTORY, No. 1, Shi Tang Bei Street 2, Shi Jie Town, Dong Guan City, Guang Dong, P.R.China
Model identifier:	SWS 9300
Input voltage:	AC100 - 240V
Input AC frequency:	50/60Hz
Output voltage:	DC5.0V
Output current:	0.6A
Output power:	3.0W
Average active efficiency:	≥69.64%
Efficiency at low load (10 %):	≥58.84%
No-load power consumption:	≤0.10W

INSTRUCTIONS AND INFORMATION REGARDING THE DISPOSAL OF USED PACKAGING MATERIALS

Dispose of packaging material at a public waste disposal site.

DISPOSAL OF USED ELECTRICAL AND ELECTRONIC APPLIANCES



The meaning of the symbol on the product, its accessory or packaging indicates that this product shall not be treated as household waste. Please, dispose of this product at your applicable collection point for the recycling of electrical & electronic equipment waste. Alternatively in some states of the European Union or other European states you may return your products to your local retailer when buying an equivalent new product. The correct disposal of this product will help save valuable natural resources and help in preventing the potential negative impact on the environment and human health, which could be caused as a result of improper liquidation of waste. Please ask your local authorities or the nearest waste collection centre for further details. The improper disposal of this type of waste may fall subject to national regulations for fines.

For business entities in the European Union

If you wish to dispose of an electrical or electronic device, request the necessary information from your seller or supplier.

Disposal in other countries outside the European Union

If you wish to dispose of this product, request the necessary information about the correct disposal method from local government departments or your seller.



The product meets EU requirements.

Hereby, FAST ČR, a.s. declares that the radio equipment type SWS 9300 is in compliance with Directive 2014/53/EU.

For the full version of the EU declaration of conformity, please refer to the following website: www.sencor.com

Changes in the text, design and technical specifications may change without prior notice and we reserve the right to make these changes.

The original version is Czech.

Manufacturer: FAST ČR, a.s., Černokostecká 1621, Říčany CZ-251 01

SENCOR®

EN Warranty conditions

Warranty card is not a part of the device packaging.

This product is warranted for the period of 24 months from the date of purchase to the end-user. Warranty is limited to the following conditions. Warranty is referred only to the customer goods using for common domestic use. The claim for service can be applied either at dealer's shop where the product was bought, or at below mentioned authorized service shops. The end-user is obligated to set up a claim immediately when the defects appeared but only till the end of warranty period. The end user is obligated to cooperate to certify the claiming defects. Only completed and clean (according to hygienic standards) product will be accepted. In case of eligible warranty claim the warranty period will be prolonged by the period from the date of claim application till the date of taking over the product by end-user, or the date the end-user is obligated to take it over. To obtain the service under this warranty, end-user is obligated to certify his claim with duly completed following documents: receipt, certificate of warranty, certificate of installation.

This warranty is void especially if apply as follows:

- Defects which were put on sale.
- Wear-out or damage caused by common use.
- The product was damaged by unprofessional or wrong installation, used in contrary to the applicable instruction manual, used in contrary to legal enactment and common process of use or used for another purpose which has been designed for.
- The product was damaged by uncared-for or insufficient maintenance.
- The product was damaged by dirt, accident of force majeure (natural disaster, fire, and flood).
- Defects on functionality caused by low duality of signal, electromagnetic field interference etc.
- The product was mechanically damaged (e.g. broken button, fall).
- Damage caused by use of unsuitable media, fillings, expendable supplies (batteries) or by unsuitable working conditions (e.g. high temperatures, high humidity, quakes).
- Repair, modification or other failure action to the product by unauthorized person.
- End-user did not prove enough his right to claim (time and place of purchase).
- Data on presented documents differs from data on products.
- Cases when the claiming product cannot be indentified according to the presented documents (e.g. the serial number or the warranty seal has been damaged).

Authorized service centers

Visit www.sencor.eu for detailed information about authorized service centers.